

Evaluation of a DPD approach for multi standard applications

Houssam Eddine HAMOUD
Xlim, UMR 7252
University of Limoges
Limoges, France
houssem.hamoud@xlim

Sebastien MONS
Xlim, UMR 7252
University of Limoges
Limoges, France
sebastien.mons@xlim.fr

Tibault REVEYRAND
Xlim, UMR 7252
University of Limoges
Limoges, France
tibault.reveyrand@xlim.fr

Edouard NGOYA
Xlim, UMR 7252
University of Limoges
Limoges, France
edouard.ngoya@xlim.fr

Damien GAPPILOUT
AMCAD engineering
Limoges, France
gapillout@amcad-engineering.fr

Abstract—This paper exposes the evaluation of a DPD model targeting multi standard communication applications. The model is based on a continuous time modelling approach as opposite to classical discrete time approach like Volterra series and memory polynomials. It is known as Two Path Memory (TPM) model approach. In this work, the TPM DPD model is extracted and evaluated from measurements for a Silicon Bipolar Darlington Amplifier.

Keywords—Digital Predistortion, DPD, Nonlinear measurements, Behavioral modeling, memory effects, power amplifiers, TPM.

I. INTRODUCTION

The recurrent question in mobile telecommunication is how mobile operators can handle the ever increasing number of subscribers. Important works have focused on different way to allocate and share the limited resources between multiple customers, leading to efficient access protocols (FDMA, TDMA, CDMA, WDMA, OFDMA...) and higher modulation orders (QPSK, 16QAM, 64QAM...) for better spectral efficiency. However, compared to the previous category of signals with constant envelope, the recent protocols show more sensitivity to system nonlinearities due to denser constellations and higher peak to average power ratio (PAPR) of the signals. Knowing that the power amplifier is the highest energy sensitive component in the mobile network, engineers had to deal with the nonlinearities begotten by the nature of the PA, using the PA as much as possible near to the saturation region to achieve best power efficiency and combining with linearization techniques based on Digital Predistortion (DPD). Behavioral modeling based DPD [1] [2] is nowadays a mature process and its reliability depends on the PA characterization process. Volterra series seems to be a powerful tool for nonlinear device characterization by efficiently accounting of the critical nonlinear memory effects within PA. Although practical implementation of Volterra series appears to be a difficult process because of extensive number of coefficients, many simplifications of Volterra series have been validated, like Generalized Memory Polynomial (GMP) [3] and Dynamic Deviation Reduction (DDR) [4], and are implemented today in various technologies within mobile handsets and base stations.

Common DPD models are optimized for a specific communication standard, and hence tend to be ineffective on different types of standard, in which case an update of model coefficients is indispensable. Dependency of DPD model coefficients to the signal standard can be an important drawback, especially for future multiple wideband communication standards, like 5G with higher data rates support. The need for dynamic DPD coefficients update requires a coefficient update feedback loop that makes the system architecture complex, expensive and hard to achieve large bandwidth linearization. Therefore, it is of strong interest to investigate for DPD models with less coefficient dependency on the signal standard for best achievement of large bandwidth, multiple standards application, less implementation complexity and cost.

Along this line, a new behavioral model was introduced in [5]; named Two Path Memory based Volterra (TPM), in this article we propose some practical investigation for TPM DPD. In a previous work based on simulation data sets [6], this model has shown interesting generalization property that permit to maintain a good linearization performance for many classes of signals. The model will be applied on a Silicon Bipolar Darlington Amplifier (AVAGO ADA-4543), operating at 3GHz, with 12dB of linear gain and 1dB gain compression at 3dBm output power, in order to confirm through measurements our previous concluding observations.

In the following, we give brief overview of TPM model equation and kernel identification methodology (section II), then next we introduce the characterization measurement bench used for model coefficients extraction (section III), and finally section IV describes the DPD evaluation test bench and obtained results before the conclusion.

II. TWO PATH MEMORY BASED VOLTERRA MODEL (TPM)

TPM model is a continuous time integral based model derived from empirical physical observations that take into account the interaction between long-term memory and short-term memory effects.

Short-term memory corresponds to the unmodulated carrier frequency response of the amplifier. Whereas the long-term

memory reflects impact of the low pass filters in the biasing network and thermal effects on the modulation signal. The simplified equation of TPM model for DPD is:

$$x(t) = \left[1 + \int_0^\infty h_{LT}(|y(t-\tau)|, \tau) |y(t-\tau)| dt \right] \cdot \int_0^\infty h_{ST}(|y(t-\tau)|, \tau) y(t-\tau) dt \quad (1)$$

where $y(t)$ and $x(t)$ are respectively the input and output signal of the DPD, as illustrated in Fig.1, G_{PA} being the desired gain of the linearized PA.

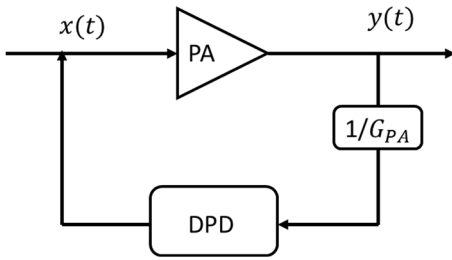

Fig. 1. DPD modeling principle

To identify the model kernels, the PA to be linearized is driven consecutively by two elementary stimuli: a single-tone unmodulated carrier (CW stimulus) and a three-tone stimulus (one large and two adjacent small signal tones) [7], illustrated at Fig.2 and Fig.3. The power of the adjacent small-signal tones is kept small enough in order to keep low higher order intermodulation products. Measurements of the three gains between same input and output tones provide a measure of the frequency domain transfer functions corresponding to the impulse responses $h_{ST}(y, \tau)$ and $h_{LT}(y, \tau)$ in equation (1). Details of equations derivations can be found in [5]. Note that because we are interested in the model of the DPD and not the PA, we will be measuring the inverse gains of the PA, i.e., input over output power (Fig.1).

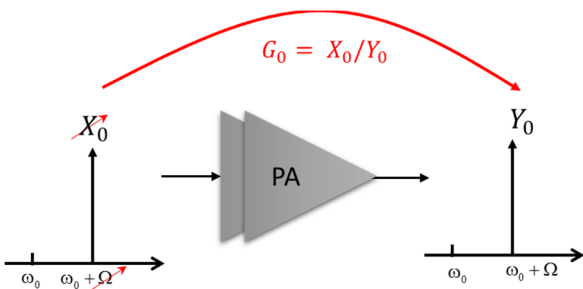

Fig. 2. One-tone stimulus characterization (sweep input power and carrier frequency, and measure inverse gain $G_0 = X_0/Y_0$).

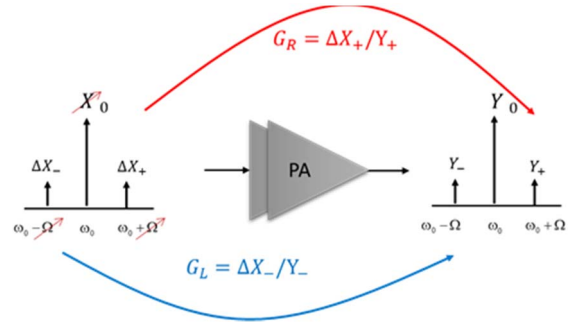

Fig. 3. Three-tone stimulus characterization (sweep large-signal tone power and frequency offset of adjacent small-signal tones, and measure inverse small-signal gains $G_L = \Delta X_- / Y_-$ and $G_R = \Delta X_+ / Y_+$)

III. TPM MODEL IDENTIFICATION PROCEDURE

A. Identification bench

The measurement bench used to characterize the PA is composed, as illustrated in Fig.4 below, of a Planar 814/1 Copper Mountain vector network analyzer (VNA) and a Rhode & Schwarz SMW200A vector signal generator (VSG). The instruments are connected by a LAN interface to allow the remote control through MATLAB program. Two bi-directional 20dB couplers, Marki C20-0R612 and variable attenuators are used to acquire the desired waves.

The VSG is used to generate both the single-tone and the three-tone stimulus. For single-tone characterization, the CW stimulus is swept in amplitude from -20 dBm to a maximum power of 0 dBm corresponding to 5 dB gain compression of the PA. Frequency of the stimulus is swept over 200 MHz bandwidth around the central frequency of 3 GHz, and the gain G_0 is collected.

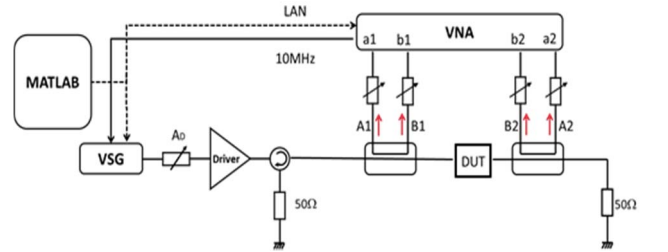

Fig. 4. Characterization test bench for TPM model

For the three-tones characterization, power of the two adjacent small-signal tones is kept at low level, -30 dBm, while power of the large signal tone is swept over the dynamic range of the PA (-20 dBm to 0 dBm). The frequency offset of the adjacent tones to the large-signal is swept from 0 to 100 MHz, to cover the bandwidth. The large-signal tone is maintained at center frequency of the PA. The input-output inverse gains G_L and G_R at the adjacent tones are collected.

B. Identification algorithm

The three gains G_0 , G_L and G_R , as a function of input power and frequency, collected in the measurement bench above will

be processed following the algorithm described in [8] to get final time-domain kernels of the model equation (1).

Broadly speaking the measured frequency domain characteristics will undergo a two-stage process; first, they are decomposed in orthogonal basis function series as in equation (2) below:

$$H_i(|y|, \Omega) = \sum_{k=0}^K \alpha_k(\Omega) \cdot f_k(|y|) \quad (2)$$

The basis functions $\alpha_k(\Omega)$ and $f_k(|y|)$ represent respectively the linear filter mechanisms and the static nonlinearity mechanisms in the PA.

Then the power defined basis functions $f_k(|y|)$ can be interpolated using cubic splines approximants, and the frequency defined basis functions $\alpha_k(\Omega)$ are fitted with rational approximants using Vector fitting technique [9] as represented in (3).

$$\alpha_k(\Omega) = \sum_{n=0}^{N_k} \frac{R_{k,n}}{\Omega - P_{k,n}} \quad (3)$$

The poles and residues of the frequency domain basis functions thus can be used to recompose the impulse responses $h_{ST}(y, t)$ and $h_{LT}(y, t)$ defined in (1).

Note that once the poles and residues of the model are calculated, the continuous time integral model of the DPD can be readily digitized in an effective way, using trapezoidal integration scheme, valid for any incoming input signal. For illustration Fig.5 and Fig.6 show respectively the single-tone and three-tone measurement characteristics of the PA: $1/G_0$, $1/G_L$ and $1/G_R$.

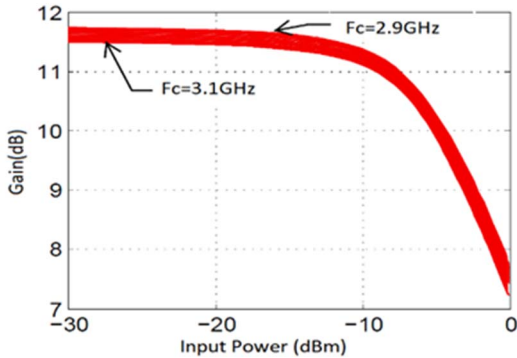

Fig. 5. Single tone measurement characteristic, cluster of CW gains for varying frequency ($1/G_0$)

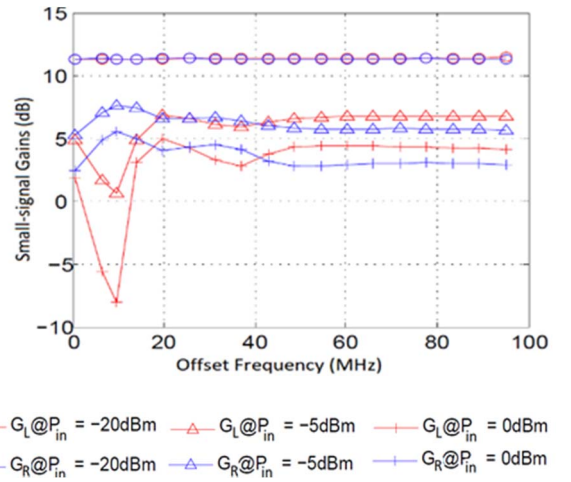

Fig. 6. Three-tone measurement characteristics, samples of right and left tone gains $1/G_R$ and $1/G_L$ (for three input power levels)

After fitting with the above described process, the normalized mean square error of the three characteristics is given in table 1.

TABLE I. FITTING ERROR FOR THE THREE PARAMETERS

Model characteristics	G_0	G_L	G_R
NMSE (dB)	-37.6	-30.7	-30.1

IV. DPD EVALUATION TEST BENCH & RESULTS

The DPD evaluation test bench is composed of a VSG (SMW200A) and a VSA (FSQ8) from Rhode & Schwarz (Fig.7). The bench is calibrated in available power. We apply the following two-step calibration procedure:

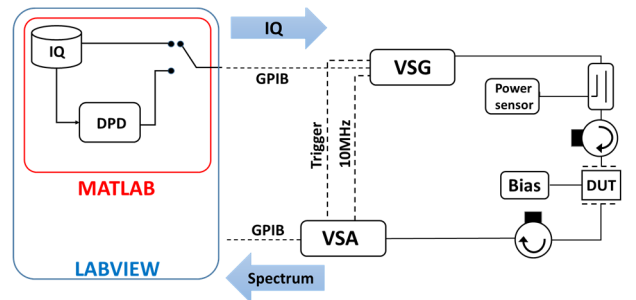

Fig. 7. DPD evaluation test bench

First, a reference power sensor, connected at the DUT's input reference plane, is considered as a power calibration sensor. The power offset is identified as a function of frequency in order to de-embed the measured power on the coupled sensor to the input reference plane.

Then, a direct connection configuration enables to extract the power offset between the spectrum analyzer and the output

reference plane. Those calibration steps are performed in CW mode for several frequencies in the bandwidth of interest.

During measurements, a modulated signal RF power sweep will be applied to the power amplifier under test up to its 1dB CW gain compression point (P_{1dB}). For each power point, a new IQ complex envelope is uploaded to the VSG alternatively for non-predistorted and predistorted within Matlab.

The first evaluation stimulus used is a 16QAM signal exhibiting a PAPR=5 dB, for which we will sweep the power and bandwidth.

Fig.8 shows the spectrum of the PA output signal with and without predistortion, for a -1dB back-off with respect to $P_{out,1dB}$ and 42MHz total input bandwidth.

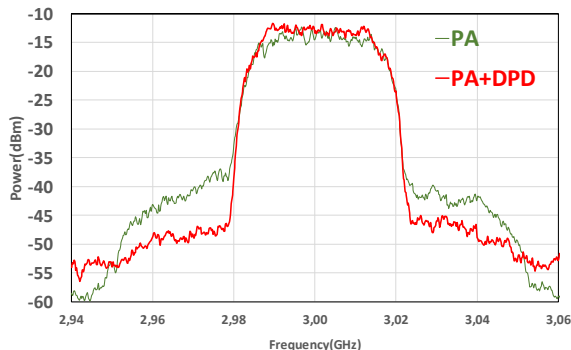

Fig. 8. 42MHz 16QAM measured output spectrum @ -1dB OBO.

We may observe the linearization performances of the DPD, with a spectrum regrowth of about 13 dB and 10 dB on the left and right side respectively.

We have then performed the sweep of input power for a fixed 42MHz bandwidth signal, and measured the resulting ACPR for PA with and without DPD configurations. The result is shown in Fig.9 as a function the output power back-off (OBO) with respect to $P_{out,1dB}$.

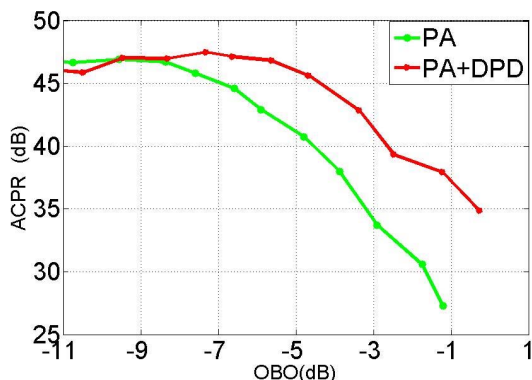

Fig. 9. ACPR for 42MHz 16QAM test signal

We may observe good ACPR improvements by the DPD, from -5 dB back-off upward. Below -5 dB back-off, the improvements are hindered by the noise floor of the VSA spectrum analyzer, which cannot accurately measure ACPR above 45 dB.

Next Fig.10 shows the ACPR plot as function of OBO for the same 16QAM signal, but with larger bandwidth, 56MHz. We observe similar DPD behavior as with 42 MHz signal bandwidth.

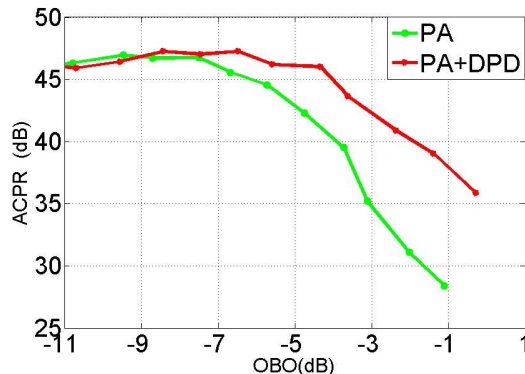

Fig. 10. ACPR for 56MHz 16QAM test signal

The second evaluation stimulus is an OFDM signal, exhibiting a PAPR of 6.6dB, with 42MHz total input bandwidth. Fig.11 shows the ACPR plot as function of OBO with respect to $P_{out,1dB}$. Again, we observe good improvements of ACPR using the same DPD coefficients.

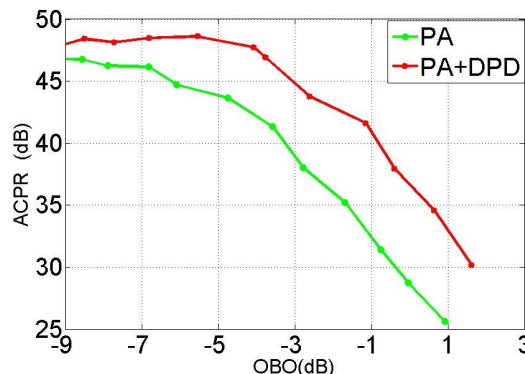

Fig. 11. ACPR for 42MHz OFDM test signal

Noting that coefficients of the DPD model were extracted from characterization with a simple three-tone stimulus, and observing the good results obtained with the same DPD coefficients for two different complex signal standards, at large bandwidths and varying input power, it is therefore a good indication that the DPD modeling approach presented can be considered as a good path of investigation for future communication system design.

V. CONCLUSION

This work has presented an evaluation of the TPM DPD model, a new approach for DPD modeling that aims to eliminate the need for signal-wise DPD coefficient re-evaluation, while maintaining a constant linearization efficiency for all standards. This would lead to important system architecture simplification and reduced cost. TPM DPD model coefficients are obtained once for all by characterizing the PA using a simple three-tone stimulus (one large-signal and two adjacent small-signal tones).

The characterization bench requires two standard equipments: a VSG and regular VNA. The results obtained in this work have confirmed the good potential of the new methodology as a universal-signal DPD.

REFERENCES

- [1] Katz, J. Wood and D. Chokola, "The Evolution of PA Linearization: From Classic Feedforward and Feedback Through Analog and Digital Predistortion", in *IEEE Microwave Magazine*, vol. 17, no. 2, pp. 32-40, Feb. 2016.
- [2] L. Guan and A. Zhu, "Green Communications: Digital Predistortion for Wideband RF Power Amplifiers", in *IEEE Microwave Magazine*, vol. 15, no. 7, pp. 84-99, Nov.-Dec. 2014.
- [3] D. R. Morgan, Z. Ma, J. Kim, M. G. Zierdt and J. Pastalan, "A Generalized Memory Polynomial Model for Digital Predistortion of RF Power Amplifiers", in *IEEE Transactions on Signal Processing*, vol. 54, no. 10, pp. 3852-3860, Oct. 2006.
- [4] A. Zhu, J. C. Pedro and T. J. Brazil, "Dynamic Deviation Reduction-Based Volterra Behavioral Modeling of RF Power Amplifier", in *IEEE Transactions on Microwave Theory and Techniques*, vol. 54, no. 12, pp. 4323-4332, Dec. 2006.
- [5] E. Ngoya et al., "On the continuous-time model for nonlinear-memory modeling of RF power amplifiers", *IEEE Transactions on Microwave Theory and Techniques*, vol. 57, no. 12, pp. 3278-3292, Dec 2009.
- [6] H. Hamoud, K. El-Akhdar, S. Mons and E. Ngoya, "Evaluation of an optimal digital predistorter for multistandard systems", workshop on Integrated Nonlinear Microwave and Millimetre-wave Circuits Workshop (INMMiC), Graz, pp. 1-3, 2017.
- [7] K. El-Akhdar, D. Gapillout, C. Mazière, S. Mons and E. Ngoya, "A phase reference standard free setup for two-path memory model identification of wideband power amplifier", 2017 89th ARFTG Microwave Measurement Conference (ARFTG), Honolulu, HI, pp. 1-4, 2017.
- [8] E. Ngoya and S. Mons, "Progress for Behavioral Challenges: A Summary of Time-domain Behavioral Modeling of RF and Microwave Subsystems", in *IEEE Microwave Magazine*, vol. 15, no. 6, pp. 91-105, Sept.-Oct. 2014.
- [9] B. Gustavsen, "Improving the pole relocating properties of vector fitting", *IEEE Trans. Power Delivery*, vol. 21, no. 3, pp. 1597-1592, July 2006.